

PLAN

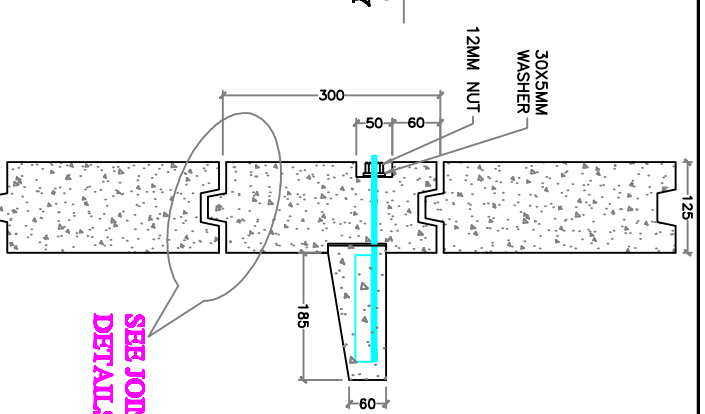

DETAILS OF FIXING FOOT STEP

SEE JOINT DETAILS "A"

SECTION

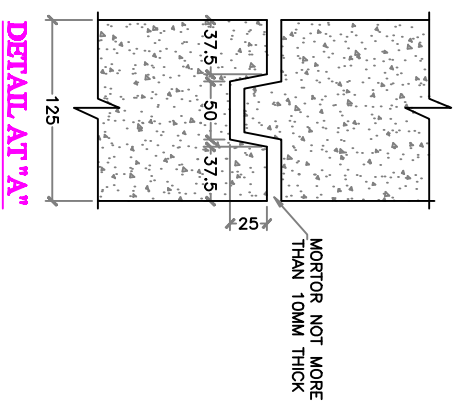
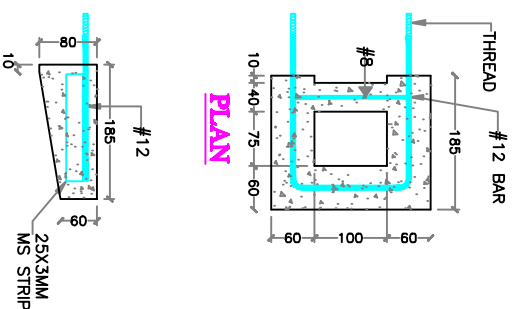

DETAIL AT "A"

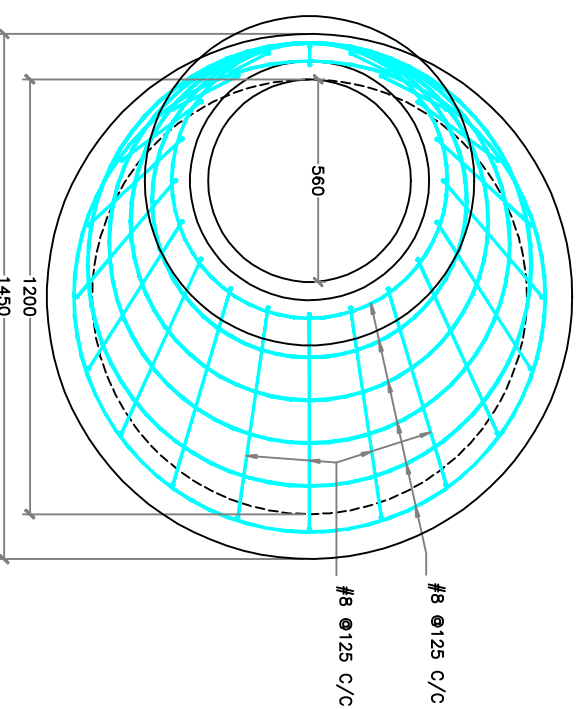

REINFORCEMENT PLAN

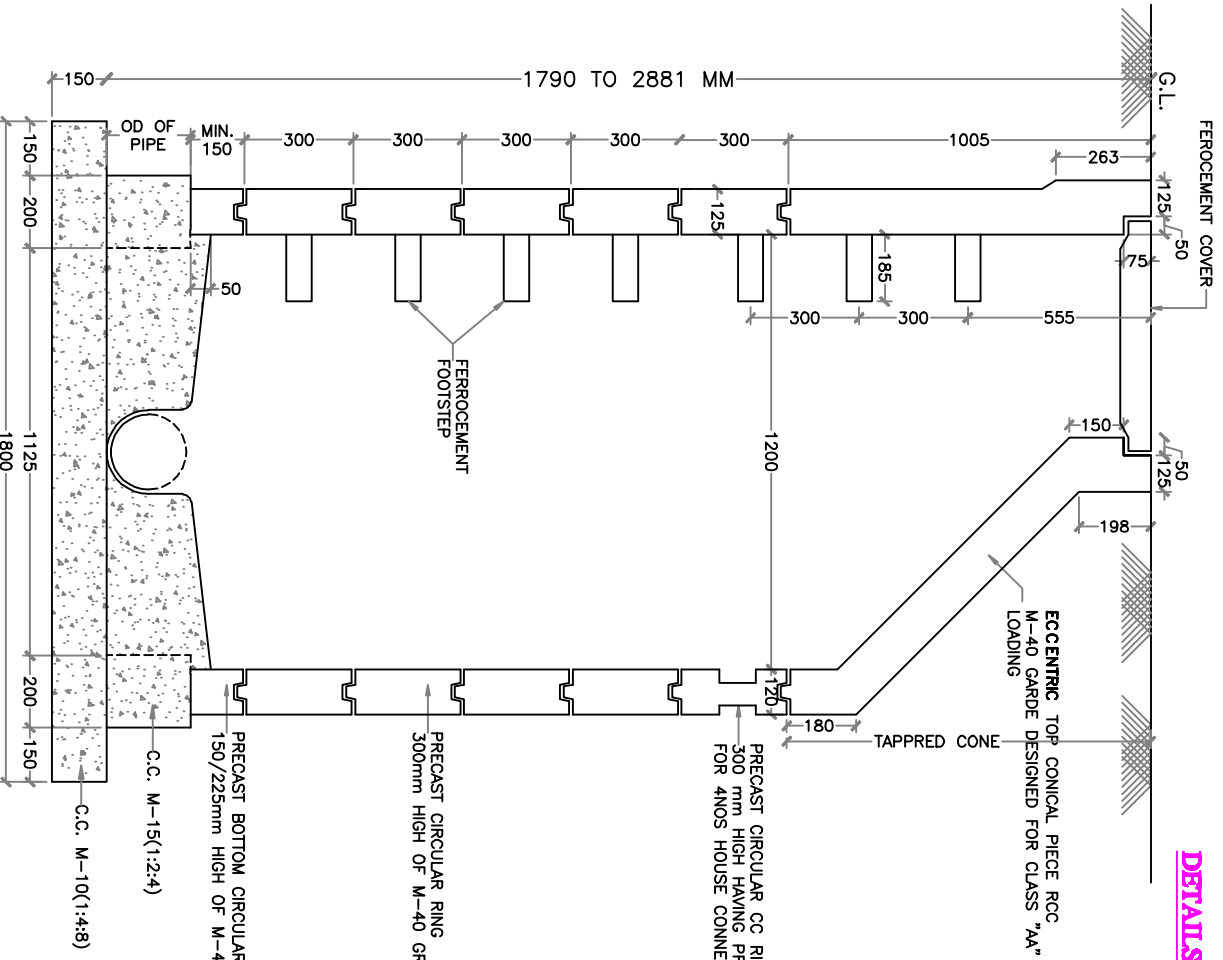

SECTION AT Y-Y

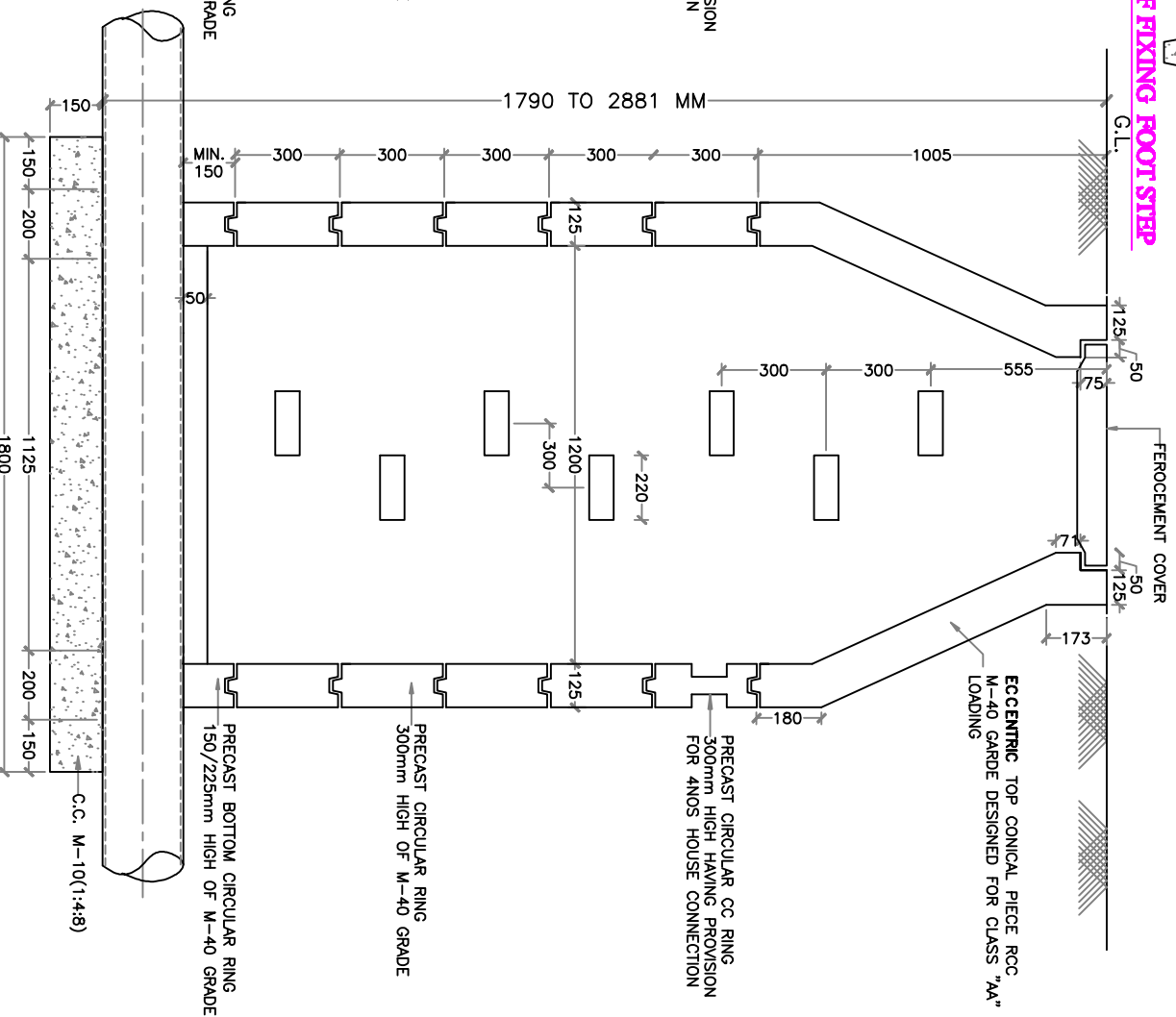

SECTION AT X-X

ALL DIMENTIONS ARE IN MM

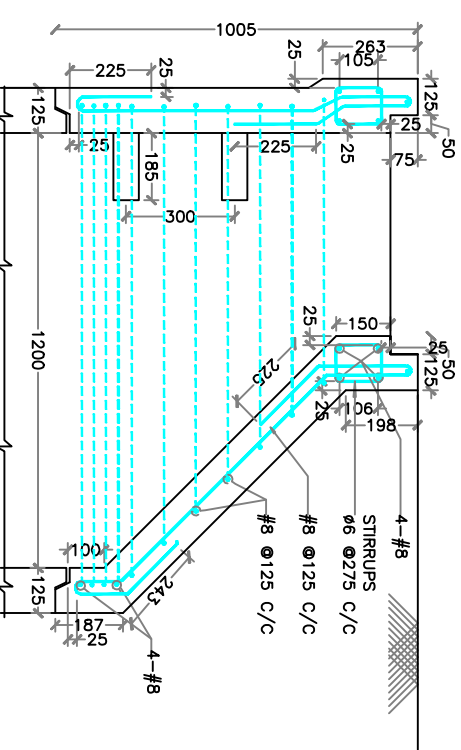

REINFORCEMENT DETAIL OF CONICAL PIECE

FOR TENDER PURPOSE ONLY

CLIENT
Municipal Commissioner Karnal
Directorate of Urban Local Bodies Panchakula
Government of Haryana



THROUGH
Executive Engineer-1st
Municipal Corporation Karnal

PROJECT
Sewerage System In Deprived Area of Karnal
Town Under AMRUT

DRG. TITLE :-
Construction Drawing of precast Man
Hole Chamber For Sewer line
Invert Depth Up To 1790 mm To 2990 mm
Internal Dia 1200 mm

SCALE :- N.T.S.

DATE :- 18/2/2017

DRG NO:- DULB/MC/AMRUT/KARNAL/SEW-04